



ADTECH
 Analog-Digital Technology, Inc.
 95 MT. READ BLVD
 ROCHESTER, NY 14611
 PHONE: 585-698-1845
 EMAIL: INFO@ADTECH-INST.COM

PTX 173

Two-Wire Non-Isolated Potentiometer Transmitter Instruction Manual

1.0 INTRODUCTION

These instructions refer to the above models. Supplementary sheets are attached if the unit has special options or features. For detailed specifications, see page 4 or refer to the Data Bulletin. All ADTECH instruments are factory calibrated and supplied with a label detailing the calibration. Adjustments are normally not necessary. A simple check should be performed to verify calibration before installation to ensure that it matches the field requirement.

2.0 GENERAL DESCRIPTION

The ADTECH Model PTX 173 Two-Wire Potentiometer Transmitter provides high accuracy conversion of 50 to 100,000 ohm potentiometer input signals to a standard 4-20 ma dc process signal.

The primary features of the PTX 173 are:

- Zero Suppression of up to 100% of the potentiometer rotation with a 16 position switch.
- Field adjustable via front accessible switches and potentiometers.
- High accuracy, repeatability, and ambient effect stability.
- RFI Protection: Standard.
- NO INTERACTION of ZERO and SPAN.
- Small size - universal mounting package provides integral RFI protection and an environmental seal.
- Options for NEMA housings, SNAP TRAK and DIN rail mounting (DIN 46 277 standard).

3.0 INSTALLATION

The instrument is supplied in a sturdy die cast aluminum housing with an epoxy paint finish. The housing is gasketed providing an environmental seal for the internal electronics and controls. NEMA 4, 7 and 12, Snap Track and DIN rail (TS32 and TS35) are optionally available. Installation area / location must agree with the supplied instruments including operating temperature and ambient conditions.

Mounting

Refer to page 3 for outline and mounting dimensions. The standard instrument is surface mounted with integral #6-32 S.S. thumb screws.

Electrical Connections

The wire used to connect the instrument to the control system Input / Output should be twisted pair(s) and sized according to normal practice. Shielded cable is not normally necessary (if used, the shield must be grounded at terminal 1 of the ADTECH instrument and left floating at the sensor).

Two barrier terminal blocks with #6-32 screws and 0.325" spacing are provided for I / O connections.

Controls

Instrument controls consist of the following:

- Two 16 position range switches for **COARSE ZERO** and **SPAN** control.
- Two multiturn potentiometers; **FINE ZERO** and **SPAN** controls.

All controls are accessible through the front of the instrument. An integral gasketed cover provides an environmental seal for the controls and internal electronics when the controls are not in use.

4.0 MAINTENANCE

These instruments are electronic and require no maintenance except periodic cleaning and calibration.

If the unit appears to be mis-operating, field wiring and/or associated circuits should be checked. MOST problems are traced to these areas.

If the problem appears to be the instrument, it may be checked as installed or removed for a bench check as detailed in sections 6.0 and 7.0.

5.0 CONNECTIONS

Standard connections are shown below and on the instrument face plate, Data Bulletin or on attached supplementary sheets.

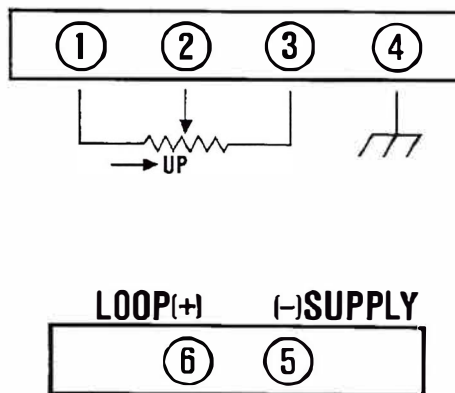

NOTE: Intrinsically safe when connected per Installation DWG 270-A-000003.

6.0 CALIBRATION

All ADTECH instruments are calibrated per your instructions at the factory. A calibration sticker located on the unit identifies the model, calibration, and options present.

To perform a calibration check or re-calibration of the instrument, please follow this procedure.

- A. Make sure the unit I / O wiring is properly connected and that the correct power source per the label is also connected. The instrument must be at normal power for a minimum of 2 minutes before proceeding to 2.
- B. The input signal source must be adjustable from 0 to 100% in steps of 10% or at least 25%. The source should be either precalibrated or an accurate meter must be used to monitor the input.
- C. The output may be monitored as a current that can be represented as a voltage across a resistor shunt.
- D. Apply an input corresponding to the zero input. Rotate the **FINE ZERO** control fully clockwise. Rotate the **COARSE ZERO** switch to a position where the zero level just goes below 4.00 ma output. Rotate the **COARSE ZERO** switch back one number less than the previous position (but not less than zero).
- E. With the input set at the zero input, adjust the **FINE ZERO** control for 4.00 ma to the desired accuracy.
- F. Apply an input corresponding to the full scale input. Rotate the **FINE SPAN** control fully counter-clockwise. Rotate the **COARSE SPAN** switch to a position where the output just exceeds 20.00 ma output. Rotate the switch back one number less (but not less than 0).
- G. With the input set to the full scale input, adjust the fine span control for 20.00 ma to the desired accuracy.
- H. Repeat steps 5 and 7 until the readings remain within to desired calibration accuracy.
- I. Check the instrument at the 25-50-75% input settings minimum.

7.0 FIELD TROUBLE SHOOTING GUIDE

This section offers a simple, first level trouble-shooting aid for an apparent instrument malfunction.

<u>SYMPTOM</u>	<u>CORRECTIVE ACTION</u>
No output	<ol style="list-style-type: none">1. Check the input and output connections carefully.2. Check that the power supply polarity is correct and that the output loop power is present on the indicated terminals.3. Check that the input source is correct and that it changes magnitude between zero and full scale values when so adjusted.4. Make sure the output loop is complete and that the correct meter range is selected. <p>All external checks are complete. Problem seems to be internal.</p>

The instrument is environmentally sealed. Troubleshooting beyond the above may be difficult without special equipment. We do not recommend attempting repair of the unit in the field. ADTECH offers a very responsive repair policy.

8.0 TABLES, OUTLINE / MOUNTING

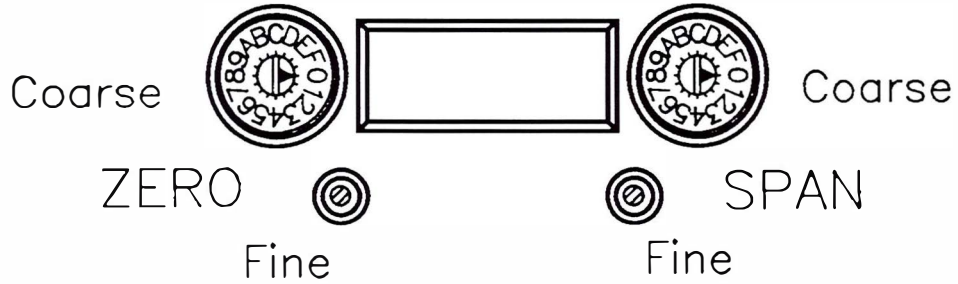

OUTLINE & MOUNTING

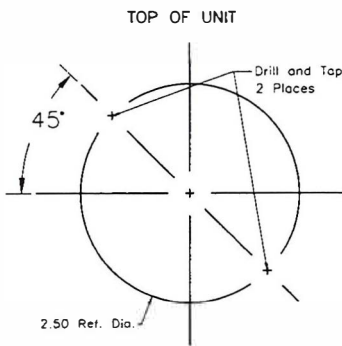

SURFACE MOUNT
STANDARD HOUSING

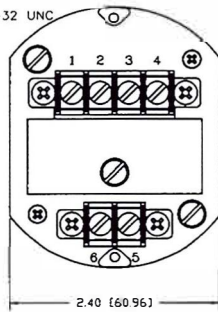

STANDARD
HOUSING

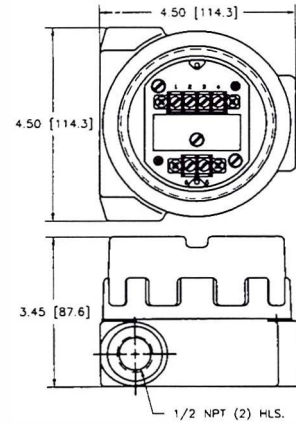
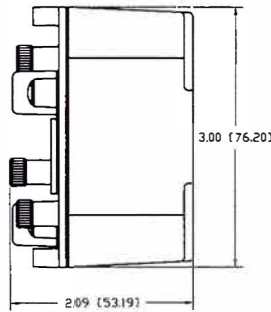

EXPLOSION PROOF
HOUSING OPTION

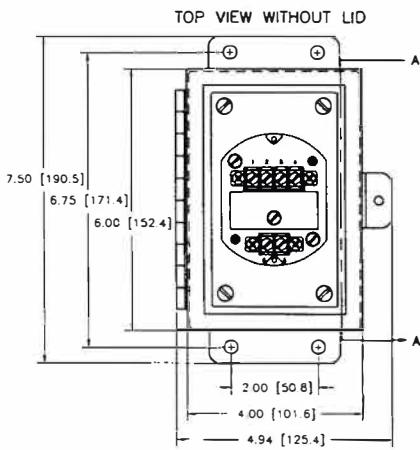

NEMA 12 = Option H144; NEMA 4 = H13A

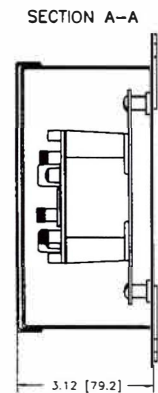

NEMA 4/12

MULTIPLE MOUNTING OPTION H 19 (8 UNITS MAX IN 24 IN. LENGTH)

NOTE: Option H22 must be ordered for Snap Track Utilization

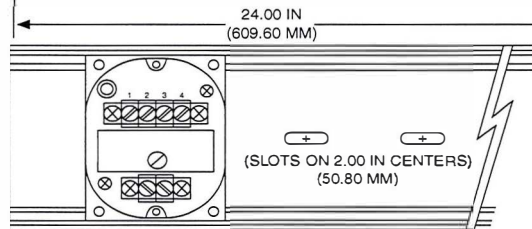

SNAP TRACK

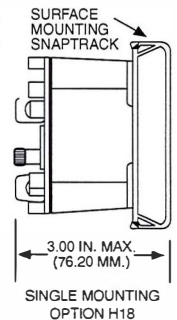

9.0 SPECIFICATIONS

INPUT/OUTPUT

INPUT SIGNALS

- Potentiometers/slidewire sensors 3 wire.
- 50 ohm to 100K ohm resistance spans: standard.
- Zero Suppression: up to 100% of the potentiometer rotation selected in 16 divisions of the coarse zero adjustment switch.
- Span: from 0-100% full scale—switch selectable. The coarse span switch adds 16 range divisions.

OUTPUT SIGNALS

- 4-20 ma dc

OUTPUT LOOP DRIVE CAPABILITY

$$R(\text{ohm}) = \frac{(V \text{ supply} - V \text{ minimum}) 1000}{I \text{ out max. ma}}$$

$$V \text{ minimum} = 8.0 \text{ vdc}$$

I out	4 - 20 ma			
V supply	12	24	36	42
R (ohm)	200	800	1400	1700

PERFORMANCE

- Calibrated Accuracy:** $\pm 0.1\%$
- Independent Linearity:** $\pm 0.02\%$ maximum, $\pm 0.006\%$ typical (14 bit digital linearity)
- Repeatability:** $\pm 0.005\%$ maximum; $\pm 0.002\%$ typical
- Zero TC:** $\pm 0.007\%$ of span max/ $^{\circ}\text{C}$
- Span TC:** $\pm 0.010\%$ of span max/ $^{\circ}\text{C}$
- Load Effect:** $\pm 0.005\%$ zero to full load
- Output Ripple:** 10 mv P/P maximum
- Response Time:** 110 milliseconds (10 to 90% step response)
- Bandwidth:** (-3 db): 0.6 Hz
- Temperature Range:** -25 $^{\circ}$ to 185 $^{\circ}$ F (-31 $^{\circ}$ to 85 $^{\circ}$ C) operating
-40 $^{\circ}$ to 200 $^{\circ}$ F (-40 $^{\circ}$ to 93 $^{\circ}$ C) storage
- Power Supply Effect:** $\pm 0.005\%$ over operating range

Note: All accuracies are given as a percentage of span

POWER

- 8 to 42 vdc—standard

MECHANICAL

- Electrical Classification: general purpose, CSA pending
- Connection: Barrier terminal strips
(0.325" spacing, No. 6 screws)
- Controls: Two 16 position rotary switches for **COARSE ZERO** and SPAN control
Two multiturn potentiometers for **FINE ZERO** and SPAN control
- Mounting: Surface, Snap-Track, DIN or NEMA 4, 7 & 12
- Weight: Net Unit: 8 oz. (228 grams)
Shipping: Nominal 1 pound (455 grams)

OPTIONS

Option Number	Description
H 13 through H 20	Mounting